

L.P. 34 – Interférométrie à division d'amplitude

Marchetti Benjamin

1. Intérêt de la division d'amplitude

Rappels

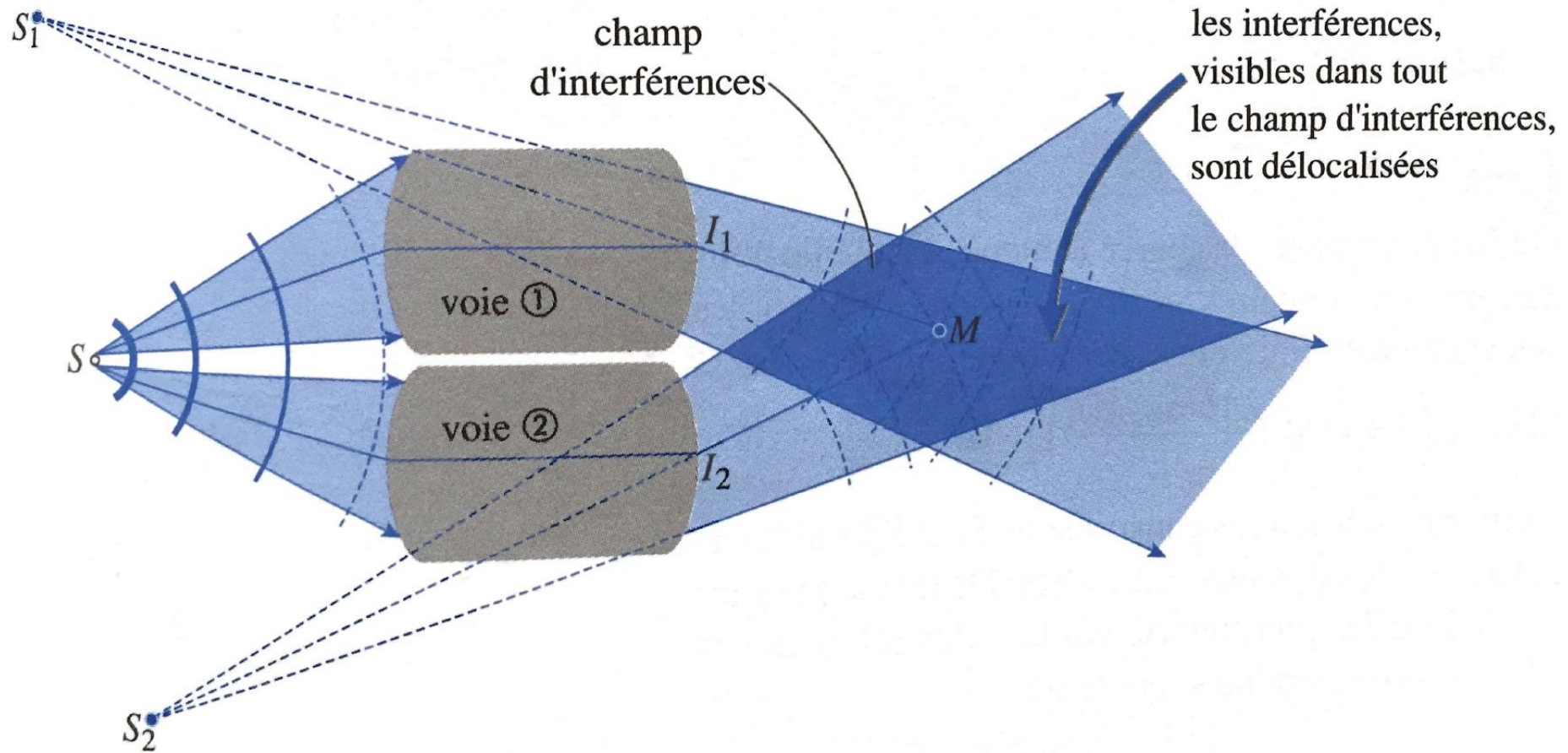

1. Intérêt de la division d'amplitude

Théorème de localisation

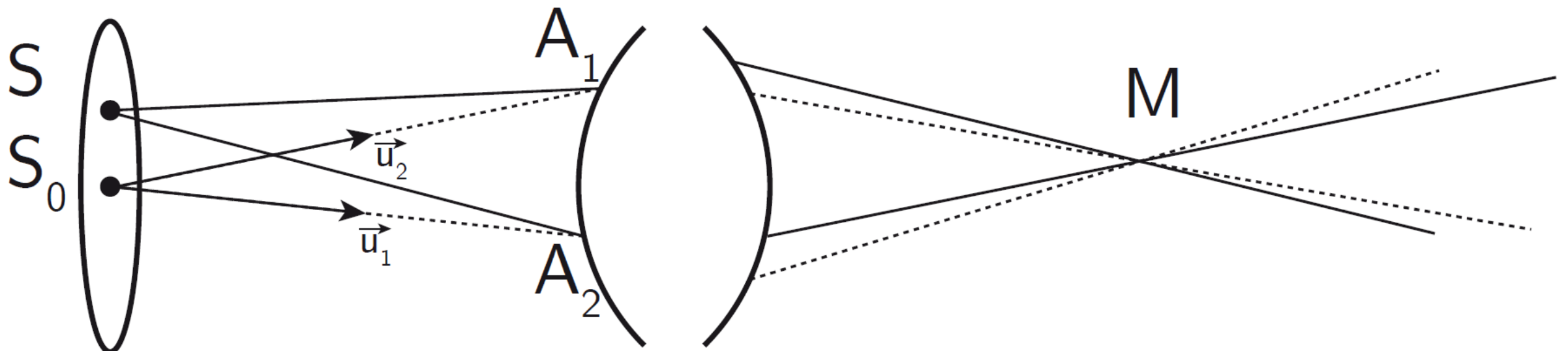

2. Interféromètre de Michelson Principe

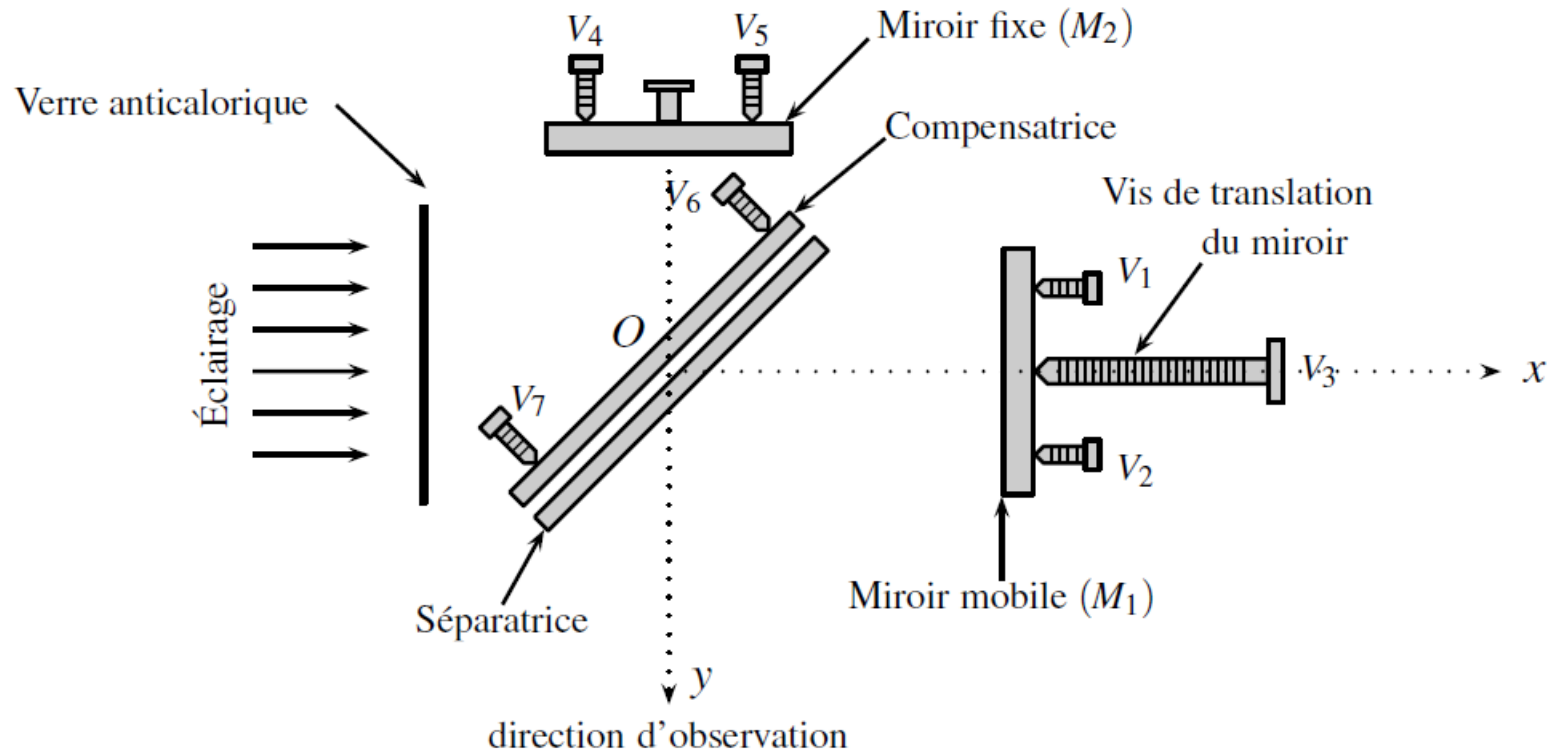

2. Interféromètre de Michelson Principe

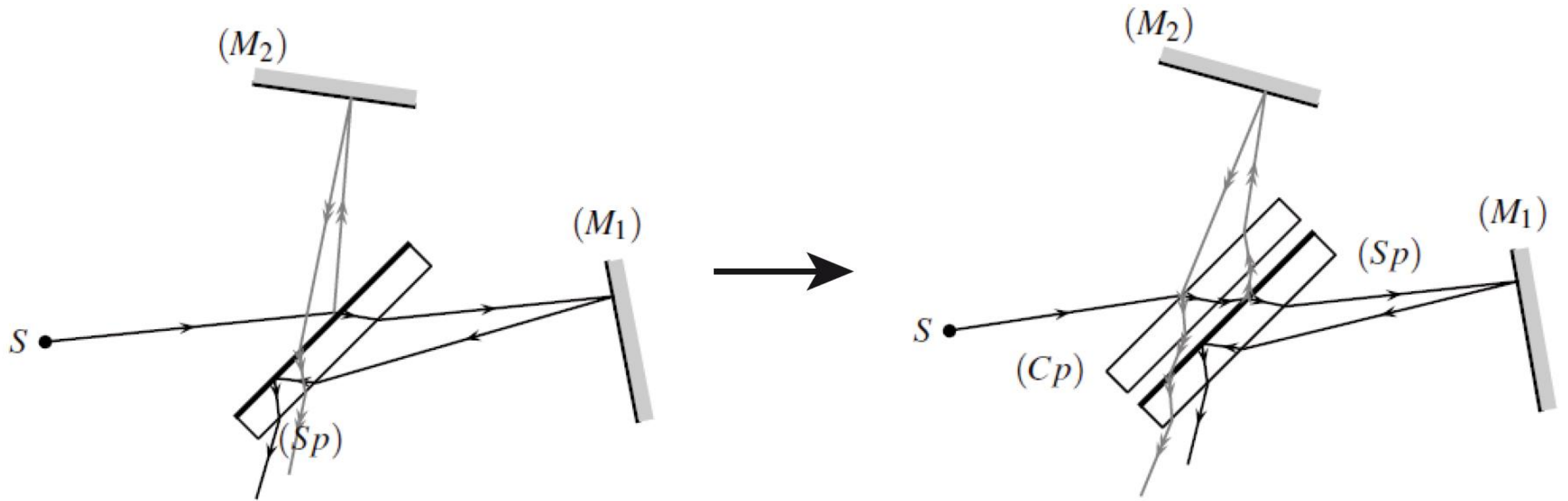

2. Interféromètre de Michelson Lame d'air

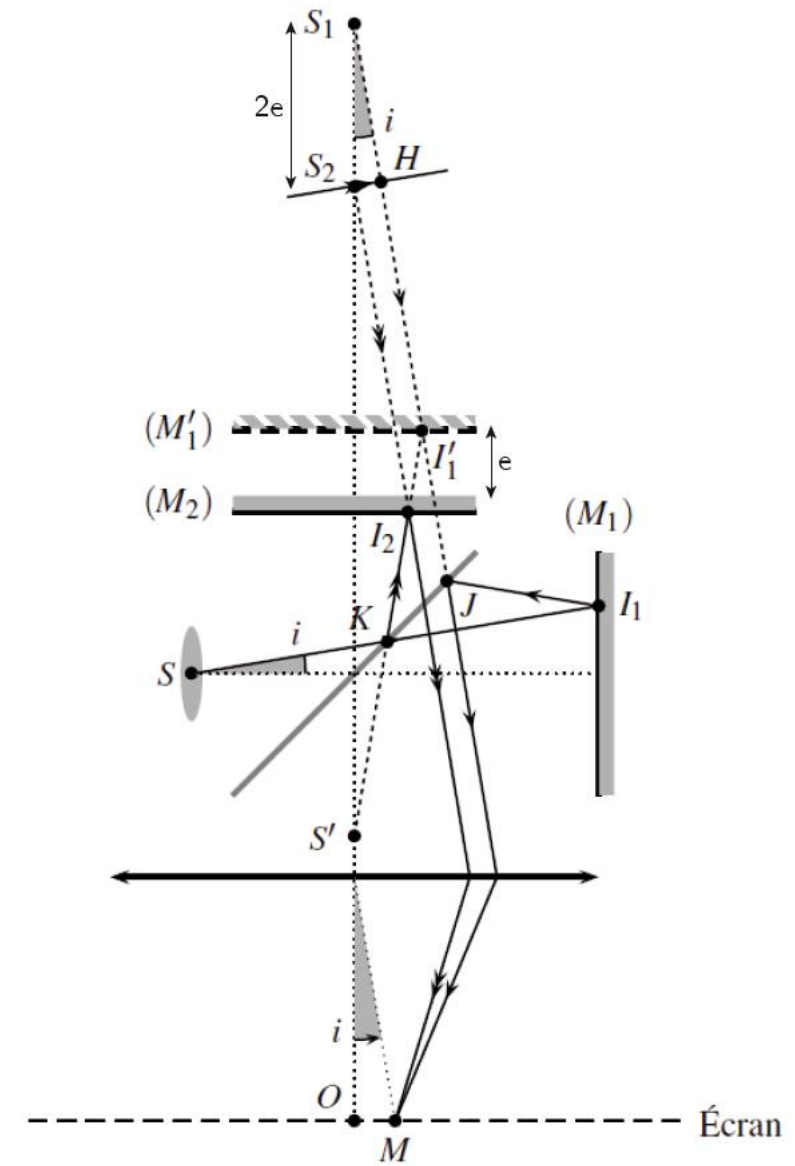
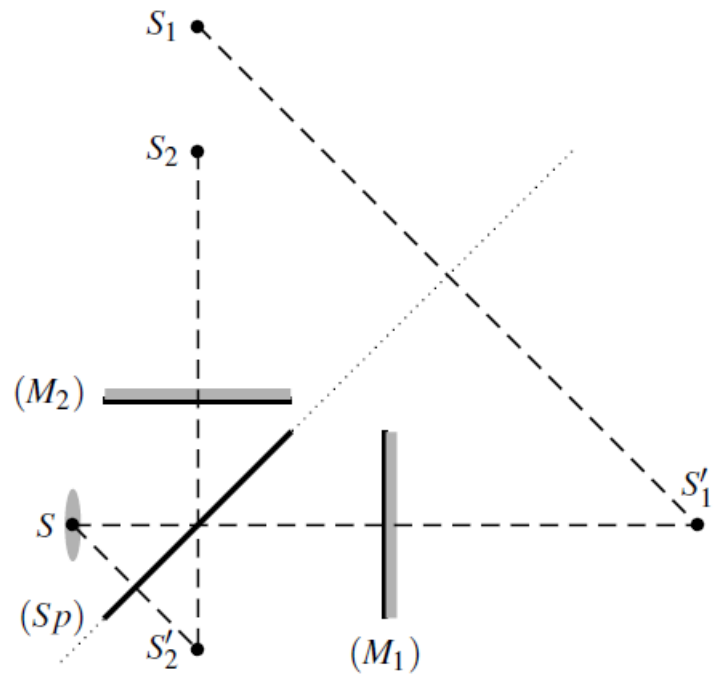

2. Interféromètre de Michelson Coin d'air

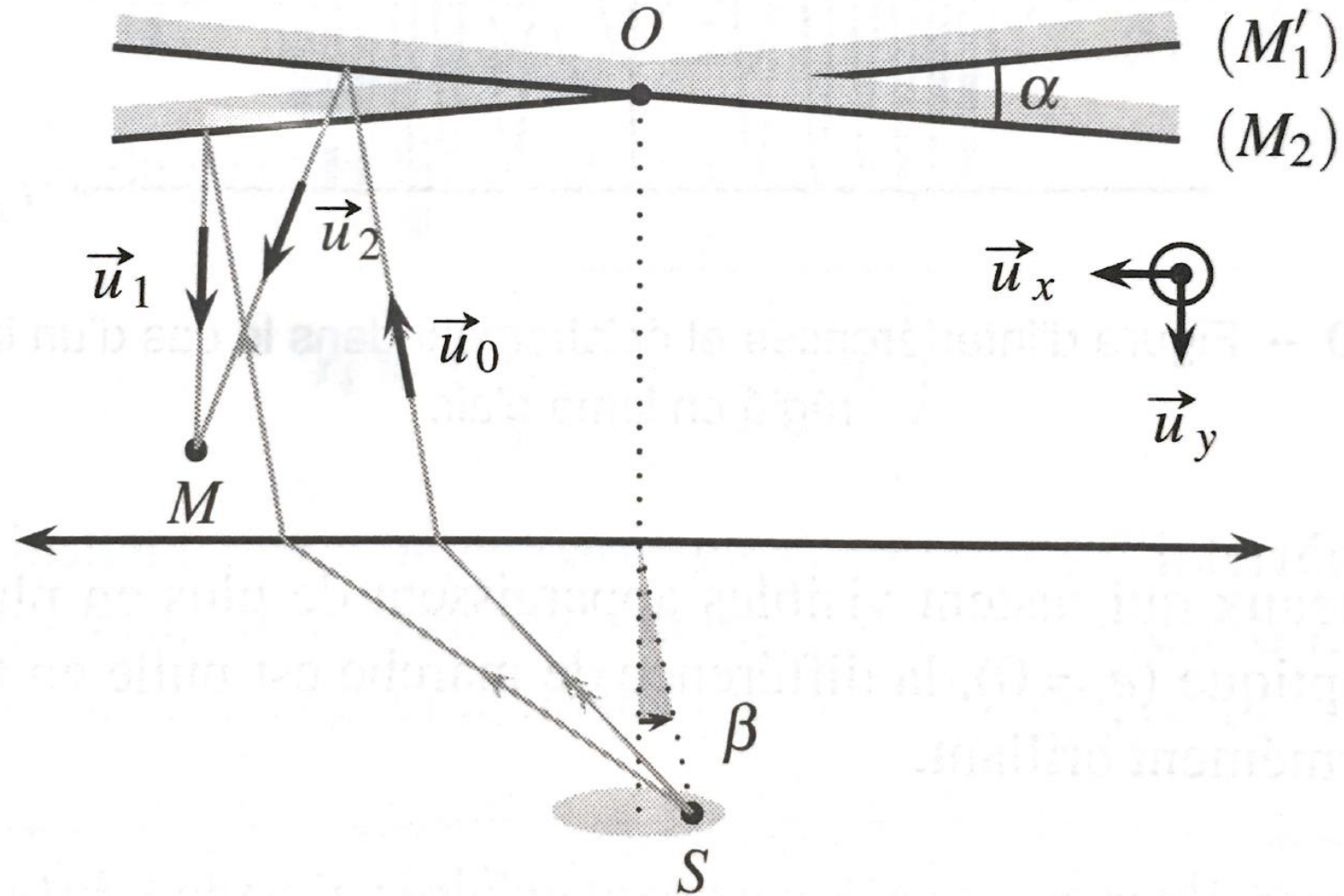

3. Interféromètre de Fabry-Pérot

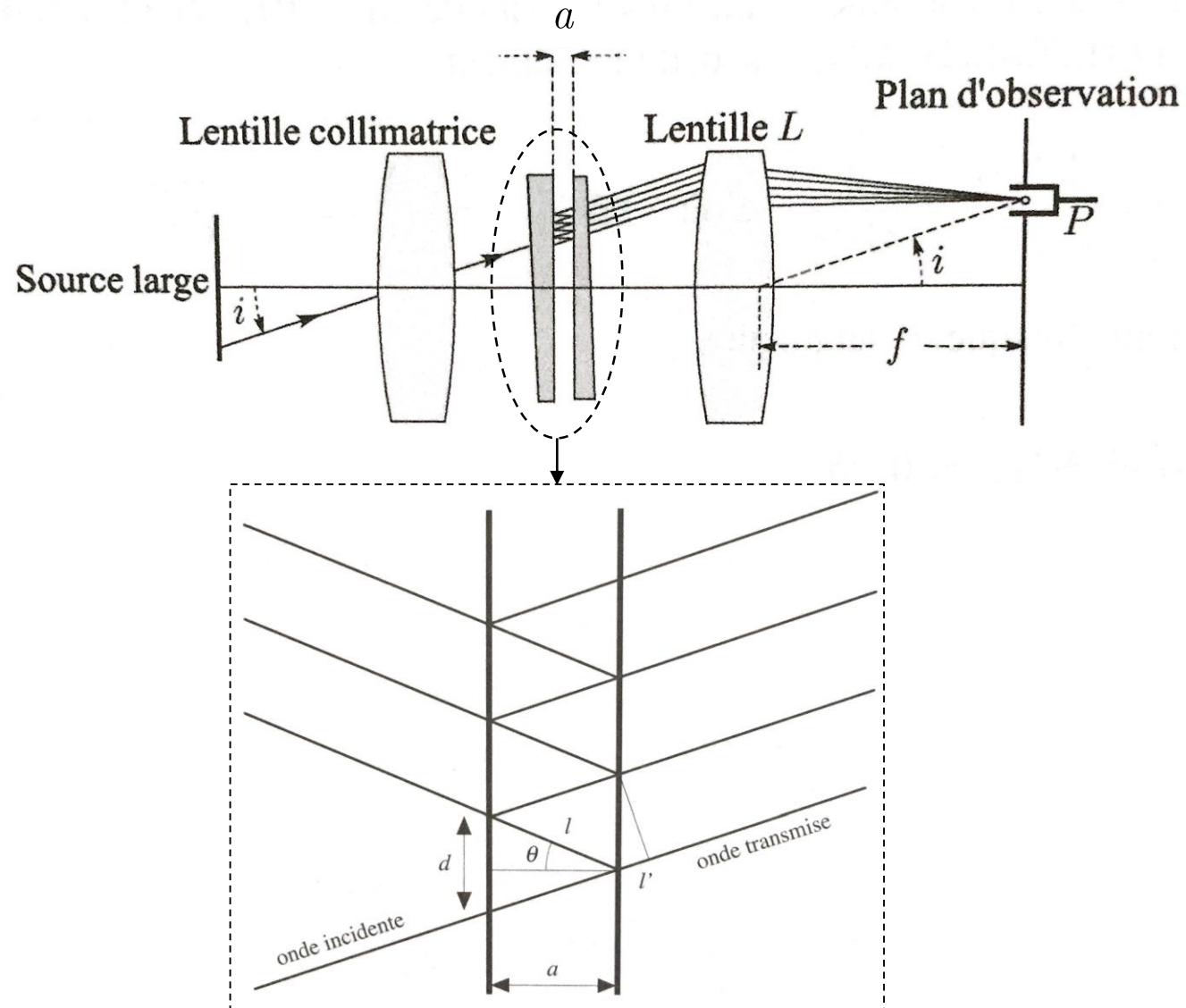

3. Interféromètre de Fabry-Pérot

